

TECHNIQUE OF WINDSHIELD DE-ICING STATE PREDICTION BASED ON NEURONAL MODEL

Alexandra BUCUR¹, Octavian POTECAȘU², Florin Bogdan MARIN³

¹ master student with the Material Engineering Department, "Dunarea de Jos" University of Galati,

² Environmental and Industry Safety Department, "Dunarea de Jos" University of Galati,

³ Material Engineering Department, "Dunarea de Jos" University of Galati,
florin.marin@ugal.ro

ABSTRACT

In this paper a technique of windshield de-icing state prediction is proposed. Parameters which affect de-icing performance in case of extreme cold conditions have been taken into account to build a data base that is used to train a neuronal model. The obtained neuronal model will be used to predict de-ice state to warn the driver not to set the car into motion and allow the heating system to further warm the car interior and assure very good visibility on windshield. The proposed system will further enhance ADAS (Advanced Driver Assistance Systems) to improve traffic safety.

KEYWORDS: windshield state, de-icing, demisting, windshield state prediction

1. INTRODUCTION

Visibility in the automotive industry is an important aspect to study for the car manufacturers [1] [2]. Ice and water film that forms on the windshield during winter times would reduce and disturb the driver's visibility at the start of the car use. Seeing clearly is of the utmost importance for the safety of every road user [3] [4]. The water film appears from the condensing water vapour on the inside surface of the windshield. Water film on windows occurs when the temperature of the glass is cooler than the ambient temperature. The water in the air condenses on the glass as soon as it reaches its dew point. The interior demisting needs to be performed as fast as possible in order to allow the driver to move the car. Window fog is caused by moist, humid air inside the vehicle coming in contact with the cold windshield before it is warmed up. There are several factors contributing to this humid air: such as driver or passenger breathing or the snow on the passenger's clothes.

The important advancement in the field of CFD allowed many researchers to investigate the various studies in the field of automobile Heating, Ventilating, and Air-Conditioning (HVAC) system. In that last decade several authors in the automotive industry investigated the de-icing problem using

numerical simulations of airflow in a passenger compartment.

Many studies on the thermal characteristics of passenger compartments have been carried out using both experimental and numerical analysis [6] [7] [8] [9] [10]. Also, there are authors who used an artificial neural network under several weather conditions to control the temperature of a cabin [11]. Several authors considered Neuronal Models to solve thermodynamics problems [16] [17] [18].

Modern CFD analysis for de-icing and demisting performance is used intensively by the automotive industry and research institutions over the last decade and even more intensively in the last years as a result of CFD technology improvement and availability [19][20]. In the past in order to verify the windshield de-icing performance for a given design we used physical tests. This process implied very high costly and important time resources. Furthermore, any change in the car design implied other tests.

In recent years several authors in the automotive industry considered the de-icing and demisting simulations and design solutions [16] [17].

Today's safety systems are designed to help vehicle passengers escape injury or death during an accident, by assisting the driver to prevent the accident. The vehicles are made even safer using Advanced Driver Assistance Systems (ADAS). There

are commercially available systems in several car models aiming to significantly reduce traffic accidents [27] [28]. To ensure traffic safety, ADAS can for example indicate traffic signs, warn the driver of an incoming crash with the front car, or warn the driver not to change lane as another car is approaching. These systems facilitate situational awareness using several complementary sensor modalities such as RADAR, LIDAR, ultrasound, camera, and (thermal) imaging [29] [30] [31]. The proposed technique is a part of a new proposed system as a part of ADAS. Such a system will allow warning the driver or even blocking the starting of the car in case there is insufficient visibility on windshield.

2. PROBLEM STATEMENT

We aim to predict the visibility of the windshield using CFD previously computed data and information from the car computer data such as outside temperature and engine temperature. Modeling such a complex system is a hard task as a lot of unknown variables that determine the windshield state must be predicted. For instance, there is no information concerning humidity in the car cabin, influenced by passenger’s presence, ice on clothes as well as the presence of ice on the outside of the windshield. The neuronal model must be tuned in such a manner to provide reliable results.

3. PROBLEM SOLUTION

Based on data previously calculated in CFD simulation and corroborating the temperature provided by OBD2 interface of the car concerning the engine water temperature, outside temperature, and inside temperature, especially in extreme cold weather scenarios, the system will issue a warning to the driver not to start the car.

The Governing model used for the numerical simulation is Momentum conservation equations (the Navier-Stokes equation). We considered the vehicle compartment fluid as incompressible fluid.

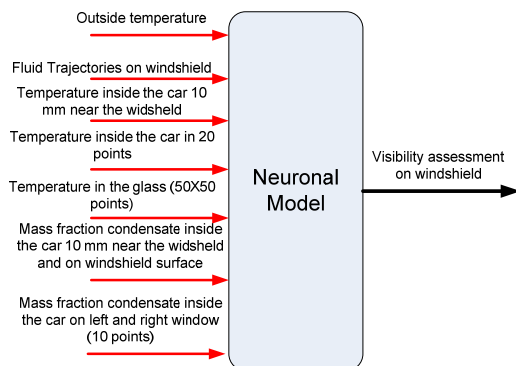

Fig. 1. The inputs of the neuronal model (red lines) and the output (black line)

A simplified 3D model is created and all the tests are performed over it. Since the model is non-real, comparison of simulation results with actual experimental results are not available to comment on the accuracy of the simulation results. The paper proposes a technique to predict the de-icing state and demisting state to warn the driver to wait for the ventilation system of the car to allow defrosting of the windshield. Parameters which affect de-icing performance in case of extreme cold conditions have been taken into account to build a data base that is used to train a neuronal model.

The obtained neuronal model will be used to predict de-ice state to warn the driver not to start the car and allow the heating system to further warm the car interior and assure very good visibility on windshield. Initial conditions for CFD simulation are considered as follows.

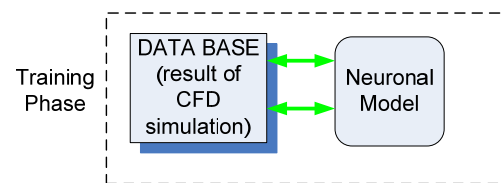

Fig. 2. The training phase of the neuronal model

The initial temperature of the compartment was the outside temperature (we modeled temperatures from -35 to 0°C. The defroster grillers were employed to inject the air at a velocity of 7 m/s. The radiator that influences inlet temperature is considered 80°C after 5 minutes. Fixed static pressure was selected for outflow condition. Additionally, for each simulation that considered the car as static the authors also used a moving car (the airflow blow on the car influencing further the thermal condition on the windscreen). In a real case, this will also influence the engine heating rate. This aspect was not considered in this paper as this parameter is variable with the car and engine design. The 3d model is considered made of generic steel. In a real case, several materials and the level of insulation will further determine the technique to predict the de-icing state.

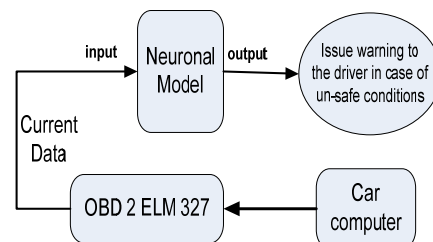

Fig. 3. The proposed system schematics

The ELM327 interface is able to send data to MS Windows laptop from a vehicle in real time by reading diagnostic codes; both generic and manufacturer-specific OBD2 allow 3000 generic code definitions.

Using such a device the user may read several data such as Engine RPM, Coolant Temperature, Vehicle Speed, Intake Air Temperature, outside temperature or inside temperature. Some car manufacturer additionally does provide some information while some do not, depending of the car computer capabilities. However, there are standard parameters that are provided by OBD2. The simulation scenario considered a CAD model of a generic van as shown in Fig. 4.

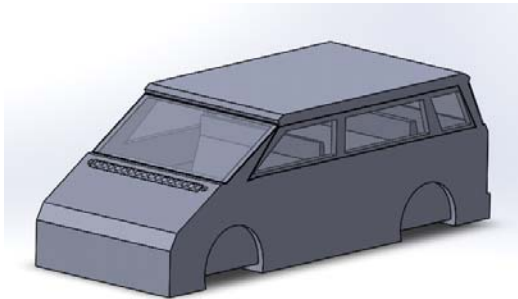

Fig. 4. Generic CAD Bus design considered for simulation

The neural network has 6 categories (Fig.1) of inputs (some are not single data but an array of data) and one output. The inputs are: 1) outside temperature, 2) Fluid Trajectories on windshield, 3) Temperature inside the car 10 mm near the windshield, 4) Temperature inside the car in 20 points, 5) Temperature in the glass (50X50 points), 6) Mass fraction condensate inside the car 10 mm near the windshield and on windshield surface, 7) Mass fraction condensate inside the car on left and right window (10 points).

The data obtained from the CFD simulations has been processed by the neuronal model which has a multi-layer structure where the error is back-propagated. The data are used to train the Neuronal Model in the training phase as shown in Fig. 2.

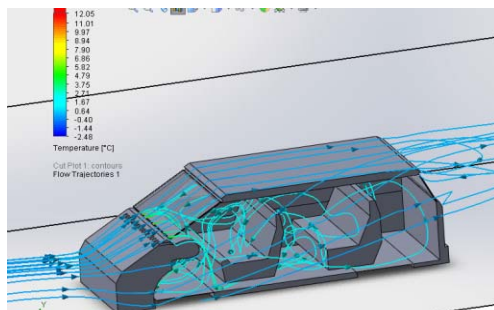

Fig. 5. Trajectories of fluid inside and outside the car

We underline several issues concerning each of the parameters. The neuronal model is specific for each car as the 3d model, ventilation capabilities varies in a considerable amount. So for every car to have such a proposed system the neuronal model needs to be re-trained. Of course the number of passengers influences the system as each person

releases more heat (about 100 W) and also more moisture. The proposed system considered the car has two passengers.

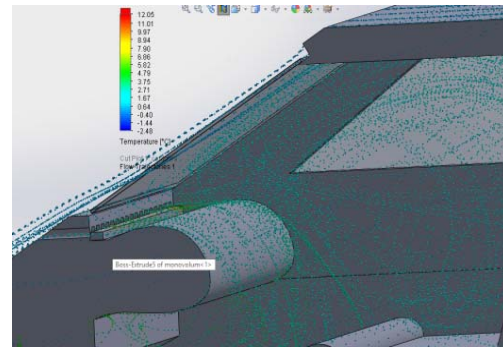

Fig. 6. Air trajectories inside the car cabin as computed by CFD simulation

However, there are few auto manufactured that provide by OBD2 the number of passengers in the car (the system that allows activating the airbag in order to protect child occupants). Fluid trajectories are described as spline curves and the CFD model considers only the case when the air vent is open for the windshield and all other vents are closed. Unfortunately few automotive manufacturer provide the state vent status.

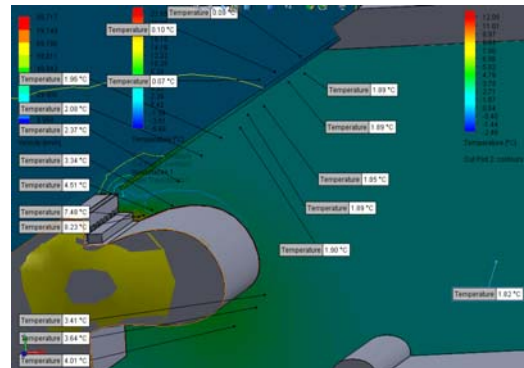

Fig. 7. Air temperature near the windshield in different locations

Temperature inside the car at the distance of 10 mm to windshield is provided as an array of 100X100. Temperature inside the car in 20 points as indicated in Fig.8 is varying with the insulation of a car. For a better performance of the system for a real car, an actual 3d model with different material and higher insulation capabilities needs to be considered. The air exit is considered at the rear of the car and doors as in real cases, which equalizes the pressure with the number of passengers influencing to a considerable degree the humidity whose level increases due to aspiration of passengers. One major drawback when using warm air to the de-icing of the windshield lies in the slow conductive heat transfer. In some cases, it can take up to 20 minutes to fully de-ice a car. Also, another important issue in case of real case scenarios is the fact that the outside windshield is

covered in snow or ice, which means different thermal transfer in the glass and, consequently, the level of ice or mist.

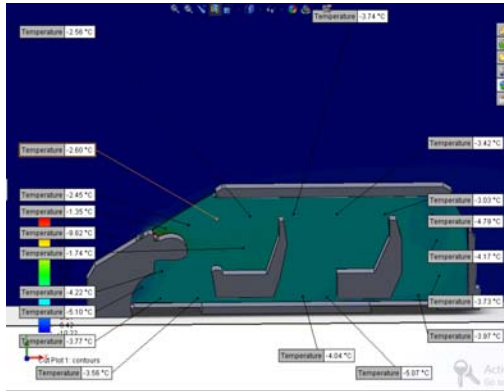

Fig. 8. Inside temperature variation in the car cabin

In this paper, we considered that there is no ice on the outside surface of the window. Another variable important for the warming of the cabin is that the intake vents on the outside are clean of ice and snow. If covered, of course the air flow will be considerably diminished. We must stress the difficulty of the problem. For instance, there is no information concerning humidity in the car cabin, influenced by the passenger’s presence, ice on clothes as well as the presence of ice on the outside of the windshield. This drawback will be overcome by using sensors inside the car cabin. However, such a system as the one proposed in this paper may be implemented only by adding an electronic module to the car computer. As shown in Fig. 8 and Fig. 9 in case of extreme cold conditions the difference of temperature inside the car is considerable, which affects directly the defrosting process of the windshield.

The proposed system schematics, as depicted in Fig. 3 use the trained neuronal model to be interrogated with current information. This information is fed to the neuronal model which outputs prediction concerning windshield status.



Fig. 9. Air temperature inside and outside the car near the windshield

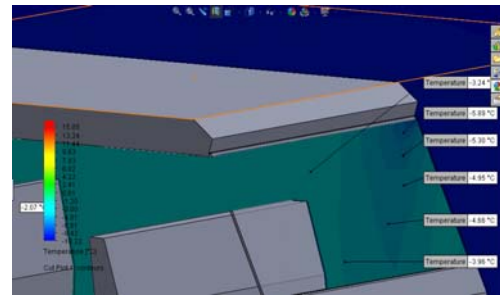

Fig. 10. Temperature on the rear window

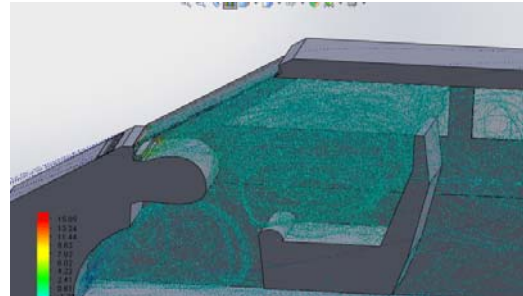

Fig. 11. Fluid trajectories inside the cabin

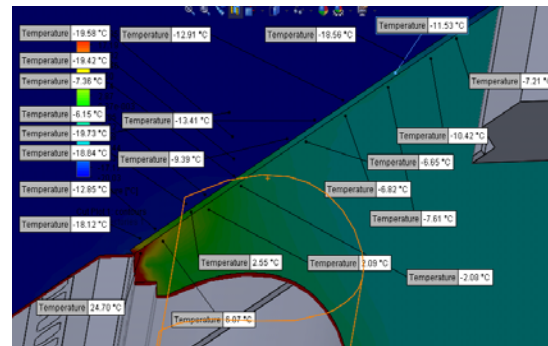

Fig. 12. Fluid temperature near the windshield

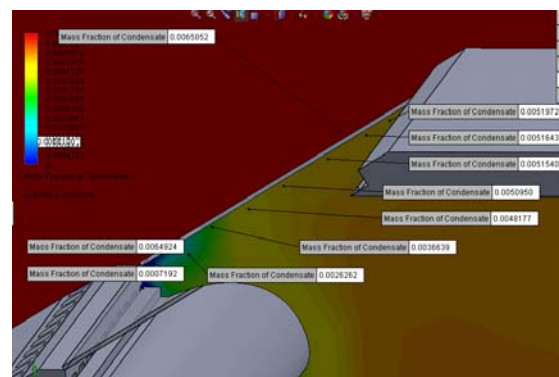

Fig. 13. Mass fraction of condensate variation inside car cabin

As seen in Fig. 13 the variation of mass fraction of condensate indicates the windshield status will not allow the driver to put the car in motion.

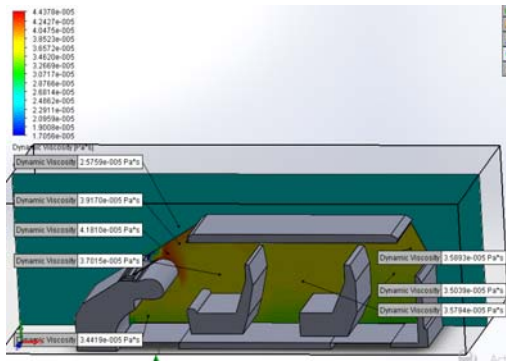

Fig. 14. Dynamic viscosity distribution

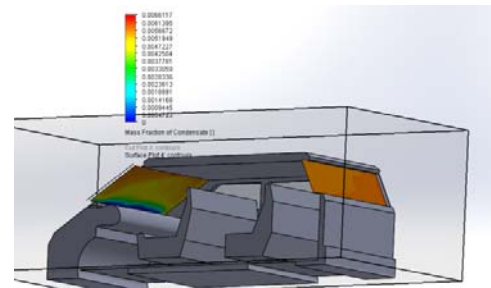

Fig. 18. Mass fraction of condensate on the windshield and rear window

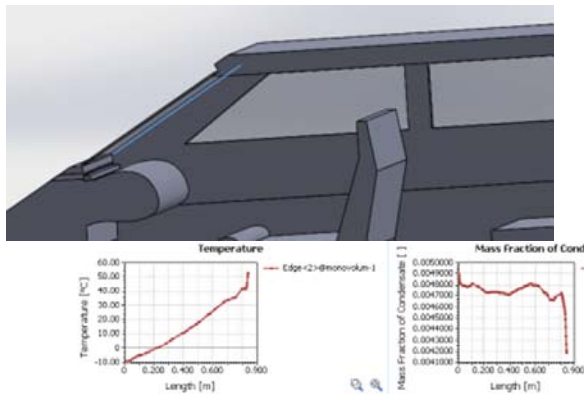

Fig. 15. Variation of temperature and mass fraction of condensate on the windshield along the position depicted by the blue line

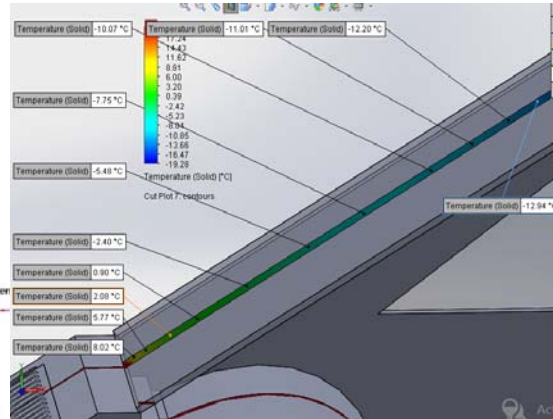

Fig. 19. Windshield temperature

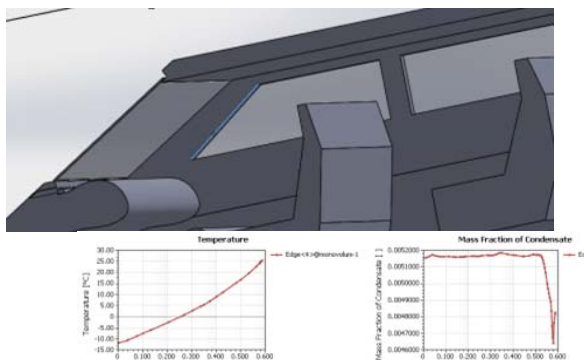

Fig. 16. Variation of temperature and mass fraction of condensate on the right window along the position depicted by the blue line (b)

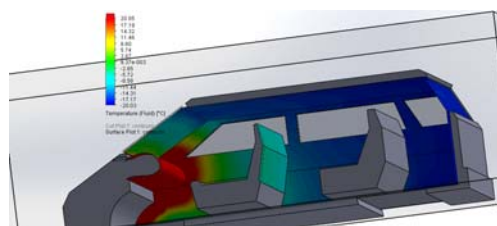

Fig. 17. Temperature variation in the material inside the car

As shown in Fig. 15, there is a considerable difference between the windshield and right windows' temperature and mass fraction of condensate, which indicates, for the case depicted, that the windshield status does not allow safe driving. The temperature and mass fraction of condensate is calculated along the lines shown in blue in Fig. 15 and Fig. 16 respectively. Also, the temperature difference of the inside cabin provides clues of initial conditions of heat distribution in case of extreme cold conditions. In Fig. 17 it is depicted the temperature in the car body inside the car. However, the model considered is a simplified model for proof-of-concept demonstration, and it is considered as of generic steel. A real model will have different materials that allow better insulation and lower heat conduction.

In this study, we used a neuronal network to train with data obtained from the experimental studies. These networks have been trained by using 50 data sets which were obtained by CFD simulation and then were useful results taken. The hardware setup consisted of a laptop computer connected to the car computer via an OBD2 interface (ELM 327) connected to an Opel Zafira computer. The program was developed in Visual C to read OBD2 information and output information to a free software NNModel. The data that was obtained from the numerical simulation was tested in the case of 3 scenarios (outside temperature -15, -10, -5 respectively) using a connected computer. As a result, it was shown that the neuronal networks algorithm obtained a good result

and it could generate results close to the experimental results. For a reliable system further real case scenarios must be performed.

4. CONCLUSIONS

The paper proposes a technique to predict the de-icing state and demisting state to warn the driver to wait for the ventilation system of the car to allow the defrosting of the windshield and not set the car into motion. A neuronal algorithm is trained using data from CFD simulation that considers actual a model of the car). The trained neuronal model is used with inputs provided by the OBD2 interface of the car concerning the engine water temperature, outside temperature, and inside temperature to predict windshield de-icing state. The authors propose a system to predict the state of de-icing and demisting in order to be integrated in the ADAS system.

Future development will include using humidity sensors in the system both in interior of the cabin and outside. Also the processing unit may be easily implemented using an embedded system. The system of prediction might be extended to predict all car windows' visibility state.

REFERENCES

- [1] **Boyce, P. R., and Gu, Y.** *Calculations of visibility levels and reaction times as a function of light transmittance for four driving scenarios (Report submitted to the International Window Film Association)*. Troy, NY: Lighting Research Center, Rensselaer Polytechnic Institute, 1994;
- [2] **Clark, B. A. J.** *Day-time hazards of windshield tinting*. Road & Transport Research, 2(4), 76-86, 1993;
- [3] **Cunningham, G.** *After-market-film on passenger car windows and light transmission*. 1993
- [4] **A. G. Gale, I. D. Brown, C. M. Haslegrave, I. Moorehead, and S. Taylor (Eds.)**, *Vision in Vehicles TV* (pp. 79-88). Amsterdam: North-Holland, 1994;
- [5] **Aroussi, A. and Aghil, S.** *Characterisation of the flow field in a passenger car model*. Optical Diagnostics in Engineering 4 ,1, 1–15., 2000;
- [6] **Aroussi, A.; Hassan, A. and Morsi, Y.S.** *Numerical simulation of the airflow over and heat transfer through a vehicle windshield defrosting and demisting system*. Heat and Mass Transfer 39, 401–405., 2003;
- [7] **Brewster, R. A. ; Frik, S. and Werner, F.** *Computational analysis of automotive windshield de-icing with comparison to test data*. SAE paper No. 971833. London & New York., 1997;
- [8] **Hara, J. ; Fujitani, K. and Kuwahara, K.** *Computer simulation of passenger compartment airflow*. SAE Paper No.881749, 1988;
- [9] **Ishihara, Y. ; Hara, J. ; Sakamoto, H. ; Kamemoto, K. and Okamoto, H.**, *Determination of flow velocity distribution in a vehicle interior using a visualization and computation techniques*. SAE paper No. 910310, 1991;
- [10] **Lee, J.-G. ; Jiang, Y. ; Przekwas, J. and Sioshansi, M.**, *Validation of Computational Vehicle Windshield De-icing Process*. SAE paper No. 940600, 1994;
- [11] **Lee, K. B. ; Jean, H. H. ; Youn, Y. M.** *Temperature Distribution Characteristics of Automobile Interior When Operating the HVAC System in the Summer*. Proc. KSME Autumn Annual Conference, 1763-1768, 2008;
- [12] **Lee, K. B. ; Kader, M. F. and and Youn, Y. M.** *Numerical Analysis Of Automobile Environment During The Cooling Period In Summer*. Proc. Micro/Nanoscale Heat Transfer Int. Conference, ASME Conference, January 6-9, 2008, Tainan, Taiwan. MNHT2008-52344, 2008;
- [13] **Lin, C. H. ; Han, T. and Koromilas, C. A.** *Effects of HVAC design parameters on passenger thermal comfort*, SAE paper No. 920264, 1992;
- [14] **Burce, S., Hassani, V., and Penny, T.R.**, *Use of infra-Red Thermography for Automotive Climate Control Analysis*, SAE Paper 931136, 1993;
- [15] **Carignano, M., and Pippione, E.**, *Optimization of wind-Screen defrosting for Industrial Vehicles Via Computer Assisted Thermographic Analysis*. SAE Paper 905237, 1990;
- [16] **Karim, J., AbdulNour, B.S., and Wiklund G.C.**, *State of Knowledge and Current Challenges in Defrosting Automotive Windshields*, SAE 980293, 1998
- [17] **AbdulNour, B.S.**, *CFD Prediction of Automotive Windshield Defrost Pattern*, SAE 01 1203, 1999;
- [18] **Flunet Inc.**, *Introduction to Renormalization Group Method and Turbulence Modeling*, Fluent Technical Memorandum, TM-107, Jan. 1993;
- [19] **Tsai H. L., Lin J. M.**, *Model Building and Simulation of Thermoelectric Module Using Matlab/Simulink*, Journal of Electronic Materials, – Vol. 39. – No. 9. – P. 2105–2111, 2010;
- [20] **Çetiner B. G., Aburas H. M.**, *Development of a Cross- Platform Artificial Neural Network Component for Intelligent Systems // JKAU: Eng. Sci., –Vol. 16. – No. 2. – P. 97–113, 2005;*
- [21] **Bayındır R., Sesveren Ö.**, *Design Of A Visual Interface for ANN Based Systems // J. of Eng. Sci. of Pamukkale University.. – Vol. 14. – No. 1. – P. 101–109, 2008;*
- [22] **Durovic, H.M., KovaZevic, B.D.**, *Control of heating, ventilation and air conditioning system based on neural network*, in: 7th IEEE Seminar on Neural Network Application in Electrical Engineering, 2004;
- [23] **Deng, Qi Qi, Shiming.**, *Multivariable control-oriented modeling of a direct expansion (DX) air conditioning (A/C) system*, International Journal of Refrigeration, Vol. 31, Issue 5, 841-849, 2008;
- [24] **Sanaye, S., Dehghandokht, M.**, *Modeling of rotary vane compressor applying Artificial Neural Network*, International Journal of Refrigeration, Vol. 34, 764-772,2011;
- [25] **Sanaye, S., Dehghandokht, M.**, *Modeling and Multi-objective optimization of parallel flow condenser using evolutionary algorithm*, Applied Energy, 88, 1568-1577, 2011;
- [26] **Yang, S.L., Arci, O., Huang, D.C.**, *A dynamic computer aided engineering model for automobile climate control system simulation and application, part 2: Passenger compartment simulation and application*, SAE paper, No. 1990-01-1196,1999;
- [27] **Z. Kim**, *Robust lane detection and tracking in challenging scenarios*, in IEEE Trans.on Intelligent Transportation Systems (TITS), vol. 9, pp. 16–26, 2008;
- [28] **A. De la Escalera, J. M. Armingol, and M. Mata**, *Traffic sign recognition and analysis for intelligent vehicles*, Image and Vision Computing, vol. 21, pp. 247–258, 2003;
- [29] **S. Thrun and M. Montemerlo**, *Stanley: The robot that won the DARPA Grand Challenge*, J. of Field Robotics, vol. 23, pp. 661–692, 2006;
- [30] **C. Urmson, C. Baker, J. Dolan, P. Rybski, B. Salesky, W. Whittaker, D. Ferguson, and M. Darms**, *Autonomous driving in urban environments: Boss and the Urban Challenge*, AI magazine, vol. 30, pp. 17–28, 2008;
- [31] **W. V. D. Mark and D. M. Gavrila**, *Real-Time Dense Stereo for Intelligent Vehicles*, vol. 7, no. 1, pp. 38–50, 2006;